

KokoLoko



KokoLoko

While observing families with babies and toddlers, I noticed that kids rarely keep their things longer than a couple of years and I am not only referring to toys. If you have a child, you know the challenges of decorating their room to be fun, but also safe and functional. Not to mention that you constantly have to move furniture or even buy new one because your child has new interests or thinks that his room is *lame* or you simply have to make space because another child is on the way. KokoLoko, a furniture collection for kids and all the *Loko* ones, was designed as an answer to those needs. Each piece presents a different combination of same eight elements. KokoLoko is a bench, stool, coffee table or a shelf, but at the same time a car track, a dollhouse, a throne or any design that gives your kid or a kid in you a possibility to create a character in a functional piece of furniture. Most objects in kid's rooms have over stimulating features such as shapes, colors, textures, characters, and therefore are predestined to last only for a short period of time. KokoLoko's subtle, yet modern design encourages kids to be creative and helps them develop space awareness, therefore creating a strong bond with a child.



KokoLoko





Collection is designed to be assembled and disassembled, easy to transport and to store, which is a problem solver when it comes to living in small spaces or moving frequently.

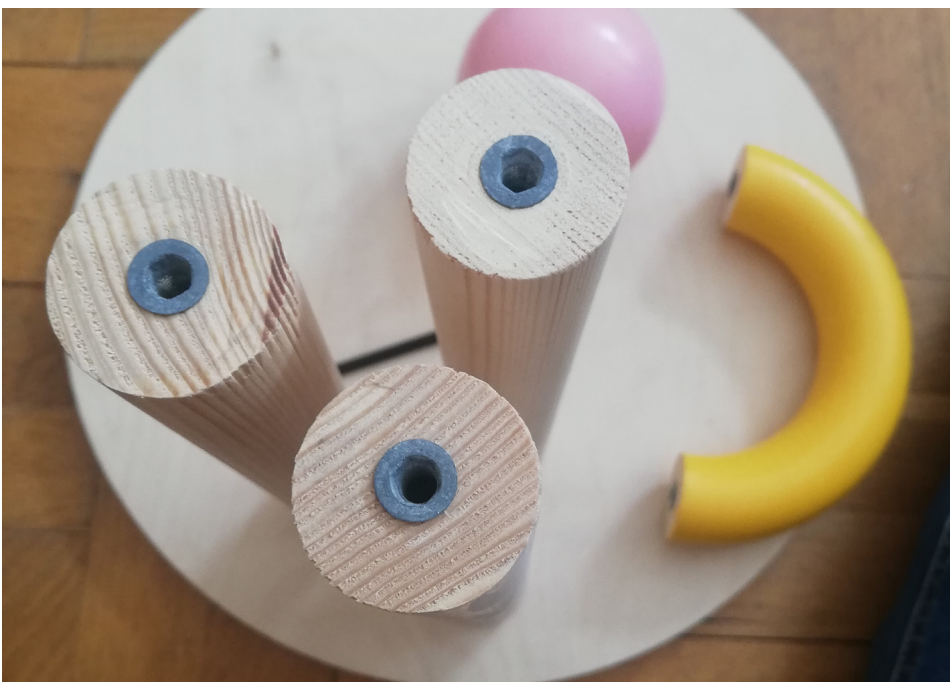

All the parts of KokoLoko furniture are separable and they connect vertically via screw, while horizontal boards pile up between screwed elements. It can be separated by hand.

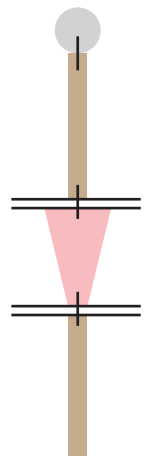
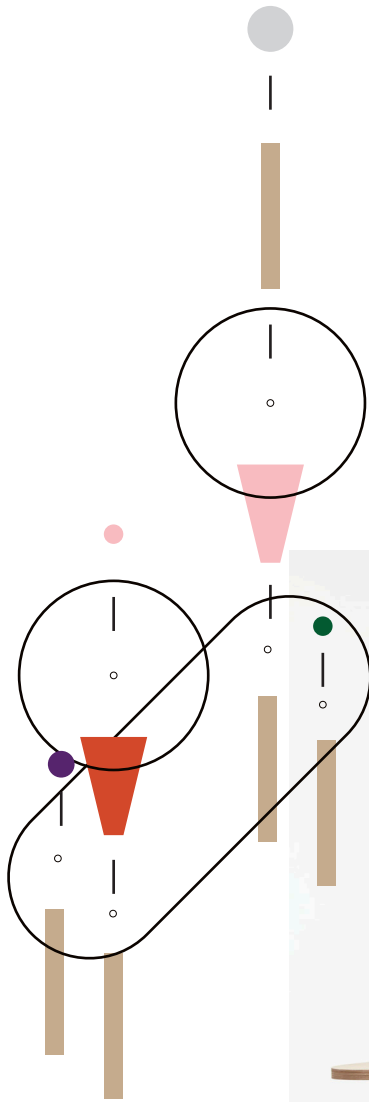

KokoLoko



Instead of hiding it, the joint is highlighted with a colorful element (sphere, cylinder or cone) designed to connect the boards. All boards have holes and all the other elements have internal screw thread that connect with each other via screws so board get stuck in between elements under and above.



In regard of connection improvement, I suggest experimenting with magnets used for joints or polymer dowel instead of screw joints.

Materials used for prototypes were oiled birch plywood and colored pinewood.

KokoLoko objects are made of multiplied cnc cut circle based plywood surfaces in combination with oldfashion woodturned objects such as cylinder, spheres, rings and truncated cones.

Due to production material improvements, instead of plywood boards, there can be incorporated variety of other materials used for same purpose, such as glass or ceramic used for tables and also lighter, but firm materials such as polymer based materials regarding kids usage.

Regarding the variations of material used for final products, price varies, but considering the materials used for prototypes and context of the similar products, estimated price range would go from 250 to 800 euro.



KokoLoko Bishop shelf



x 3



x 20



x 3



x 5



x 1



x 2



x 9

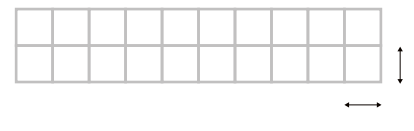
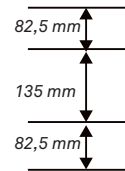
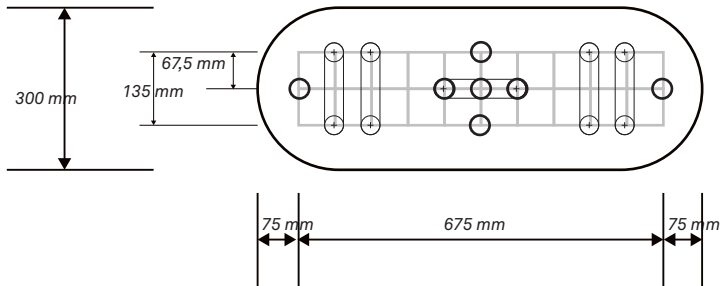
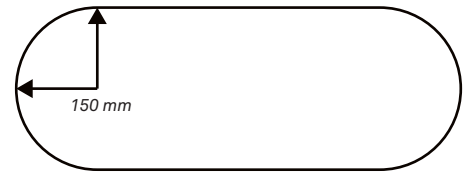
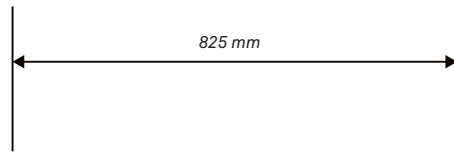

layout

67,5 mm x 67,5 mm

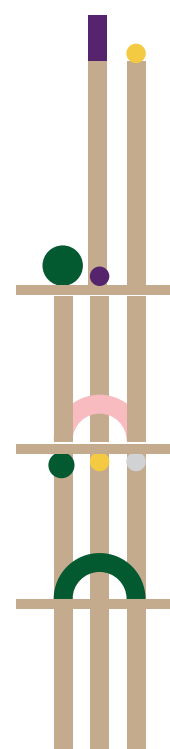
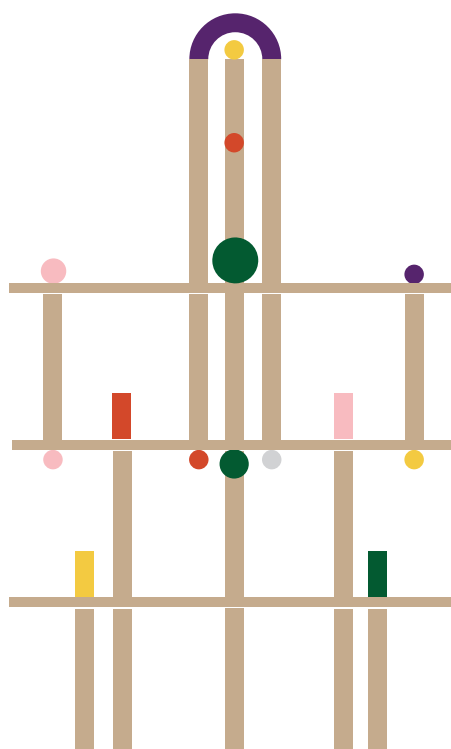
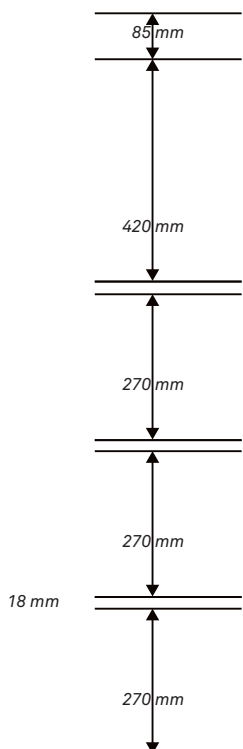

KokoLoko **Queen** table stool

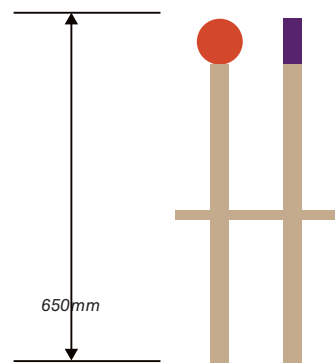
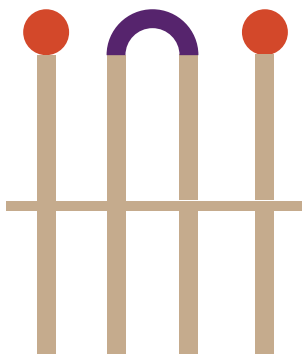
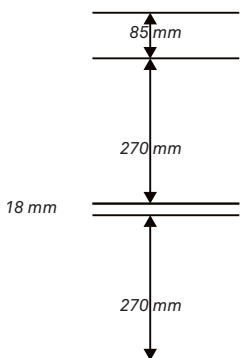
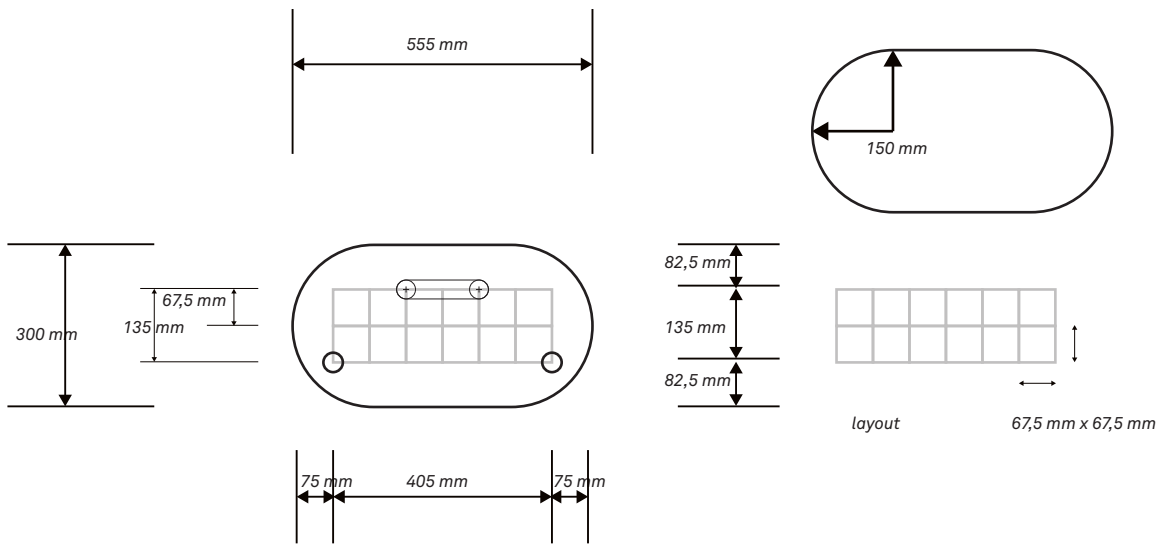
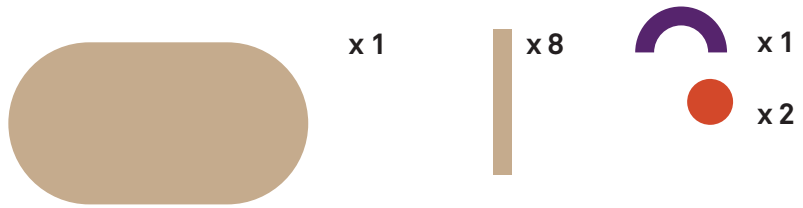

KokoLoko Charlie bench with tables

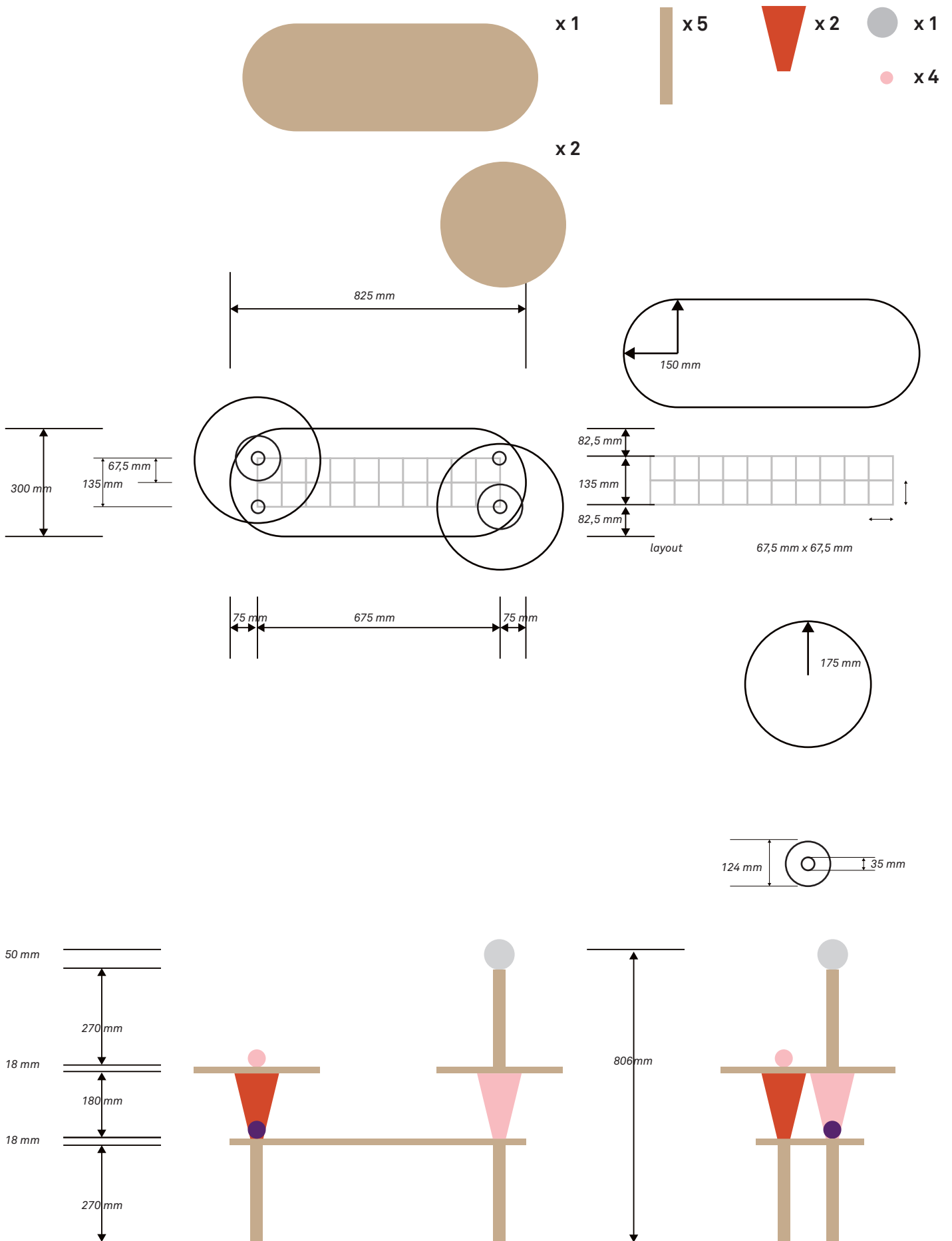

KokoLoko Countess shelf



x 2



x 8



x 6



x 2



x 1



x 1

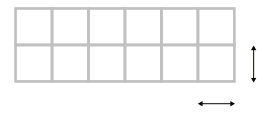
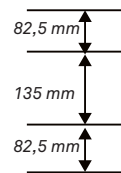
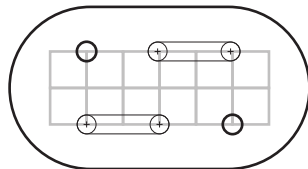
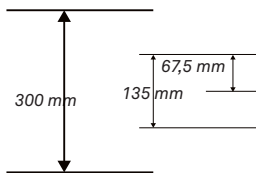
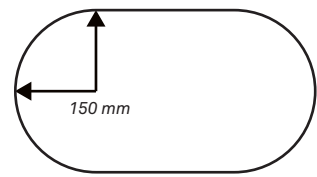
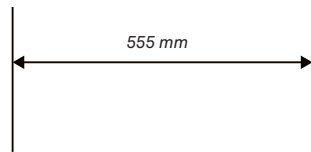

layout

67,5 mm x 67,5 mm

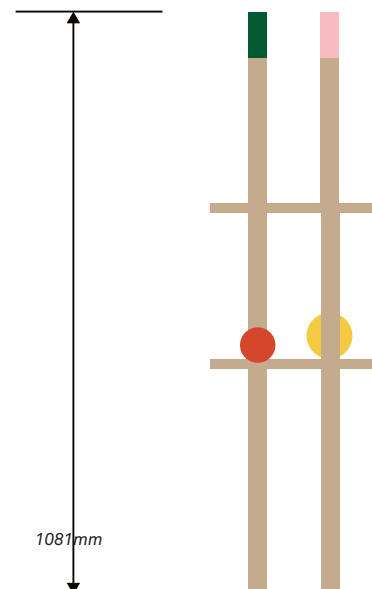
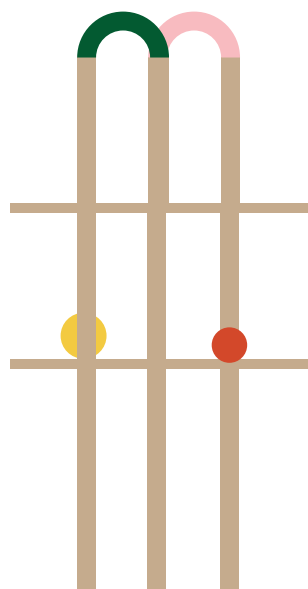
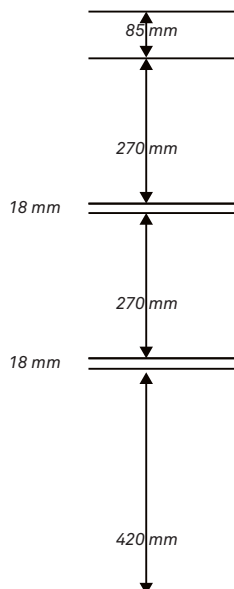
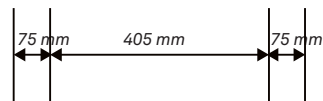

1081 mm

KokoLoko Oscar table

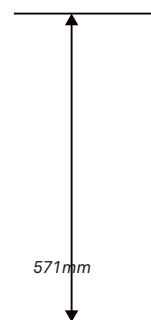
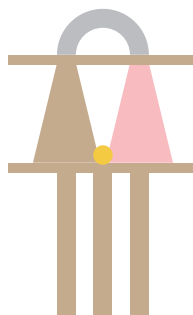
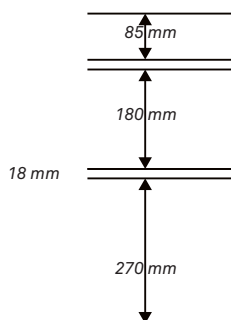
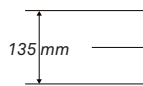
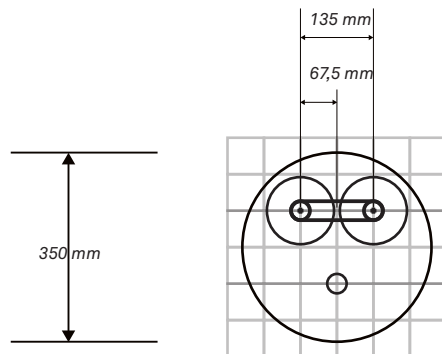
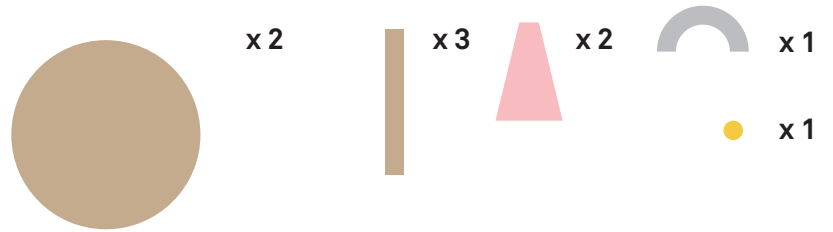



KokoLoko



thank you

